

FW200 Smart Helicopter

Smart Heli

Quick Start Guide

V1.00



Flight safety notice

Flying suggests that users enjoy flying in a reasonable safe environment. The knowledge of flight safety is very important for the safety of yourself, the surrounding people and the environment.

1. Fly in open areas away from buildings, trees, High voltage power cable lines, crowd, water surface, and any near by obstacle.
2. Please keep the transmitter in hand, even when using the Auto Flight / Auto Landing and Auto Return function, to control the helicopter at any time.
3. Please fly the helicopter within your sight range at all times .
4. ensure flight safety, please do not fly the helicopter beyond 120 meters above the ground. If there are no flying height restrictions or if the restriction is lower than 120 meters in your area, please follow the regulations

PreFlight safety inspection

Please check the helicopter carefully before taking off. Precautions are as follows:

1. Check whether the main blades, tail blades, helicopter body and landing skids are damage or distorted, please replace them with genuine Flywing RC parts
2. Check whether the flight control linkages and fuselage are fixed firmly, and whether the GPS unit is correctly fixed on the helicopter tail boom (horizontally placed, straight line behind the main mast)
3. Check whether the power of the helicopter and the transmitter are sufficient. After the transmitter is powered on, turn on the power supply of the helicopter, and check whether the helicopter passes the self inspection test (the rotor head and swashplate move regularly for several seconds)

● Flight environment requirements

1. Do not fly in bad weather, such as strong wind (10m / s), rain, snow and foggy weather, etc.
2. Choose an open place with no tall buildings around the flight pathway.
3. The vision system cannot properly in those situation: flying over surface that do not have clear pattern variations (monochrome, reflective, transparent, etc) ;flying over in an area where the lighting changes frequently or drastically.
4. Please do not fly in any area with high voltage cable line, radio tele-communication station, mobile phone transmission tower or Wi-Fi, to avoid signal interference of your transmitter and receiver.
5. Please take extra caution when flying above 6000 meters as performance of the battery and the motor power system of the helicopter will be reduced to cold temperature and thinner air density.

● Flight operation requirements

1. Keep away from rotating blades and motors
2. Fly within your sight of range (VLOS)
3. During flight, flip the stop will cause the helicopter to fall, Please do it only in case of emergency
4. Do not operate the helicopter under the influence of alcohol or drugs.
5. During the flight, please do not answer or make phone calls, send short messages or use other mobile devices that may interfere with your helicopter operation.
6. Please return home as soon as possible when low power warning appears from the transmitter.
7. In the process of return, when the radio signal is normal again, the landing position can be controlled.

8. After landing, the helicopter electronic power should be stopped first and then the transmitter should be turned off to avoid any loss of transmitter signal.
9. Please keep control of the helicopter all the way. Do not rely on GPS to provide information. In specific flight mode or flight environment, GPS system can not work normally, such as precise landing or active braking please make a reasonable judgment on the flight condition by naked eye observation, and set the corresponding flight and return altitude according to the flight environment.

Disclaimer:

The remote control model is not a toy. This product is only suitable to adults who have experience in correct model helicopter assembly, setting, commissioning and operation. The helicopter should only be flown in legal remote control flying field. This product is not suitable for children or those who do not have experience in remote control model helicopters. For inexperience or a new beginner, the helicopter must be operated under the direct supervision of someone with considerable skills or expertise. The remote control model product of this specification belongs to the operator who has high operational skills. Improper or unfamiliar use of this product may cause serious harm to yourself and others, or even death. If the product is disassembled, it can cause loss of parts in various situations. If the product is defective due to improper use, it will not be possible for us to replace with the new product or to accept return of the item, under the warranty conditions. The dealer is unable to correct the abnormal loss of parts and components, because of the end user improper installation and setting methods, modification of the goods (including use of the non-original parts), other equipment that does not meet the specifications, and poor operation. For any damage, accident or injury caused, Buyers and Operators assume full responsibility at the time of purchase. Those who can not operate any professional remote-controlled model helicopters, they shall not operate this product. At the same time, the operator must operate in the legal remote control model flying site, pay attention to the personal safety of himself and others and strictly abide by and comply with national and local laws and regulations. The whole machine hood is a fragile product. Many glass fiber parts are surface painting products. Due to shrinkage, temperature and transportation process, there may be problem of blasting and cracking on these items. This is the nature of the product itself. We can not be responsible for any serious problem after face-to-face courier signed direct delivery of the product to you, Please be aware of terms and conditions before you buy this sophisticated high tech radio control helicopter!

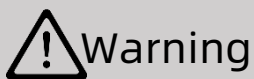

Warning

Through reading of the entire user manual to familiarize with the product functions before operation. If

the product is not operated correctly, it may cause serious injury to yourself or others, or cause product damage and property loss. This product is complex, it needs to be familiar with it for a period of time before safe usage, and you need to have some basic knowledge before operation. If there is no strong safety awareness, improper operation may lead to product damage and property loss, and even cause serious injury to oneself or others. This product is not suitable for children. Do not use parts not provided or recommended by our company. You must strictly follow the company's guidelines to install and use the products. This guidance document contains safety, operation and maintenance instructions. Be sure to read all instructions and warnings in the user's manual carefully before assembling, setting up and using. You have read and understood all the contents of this document before using it.

To avoid possible injury and loss, it is important to observe the following items:

1. Users are not allowed to operate this product in any condition of poor physical or mental state such as drinking, drug taking, drug anesthesia, dizziness and fatigue, nausea, etc
2. Except in special circumstances (such as the helicopter may hit a crowd), it is forbidden to turn off the engine during the flight
3. After landing, be sure to turn off the helicopter before turning off the transmitter.
4. It is forbidden to use this product to throw or launch any dangerous object
5. The user immediately stop using the helicopter with abnormal flight status in case of accident.

The documentation of this product is subject to update without notice. Please visit <http://www.FlyWing.com> to get more.

Transmitter

FW200's transmitter is 2.4GHz, 500m control distance* Don't change your transmitter's setting. All setup is well-done. If you change setting, you will not use your helicopter normally.

About transmitter

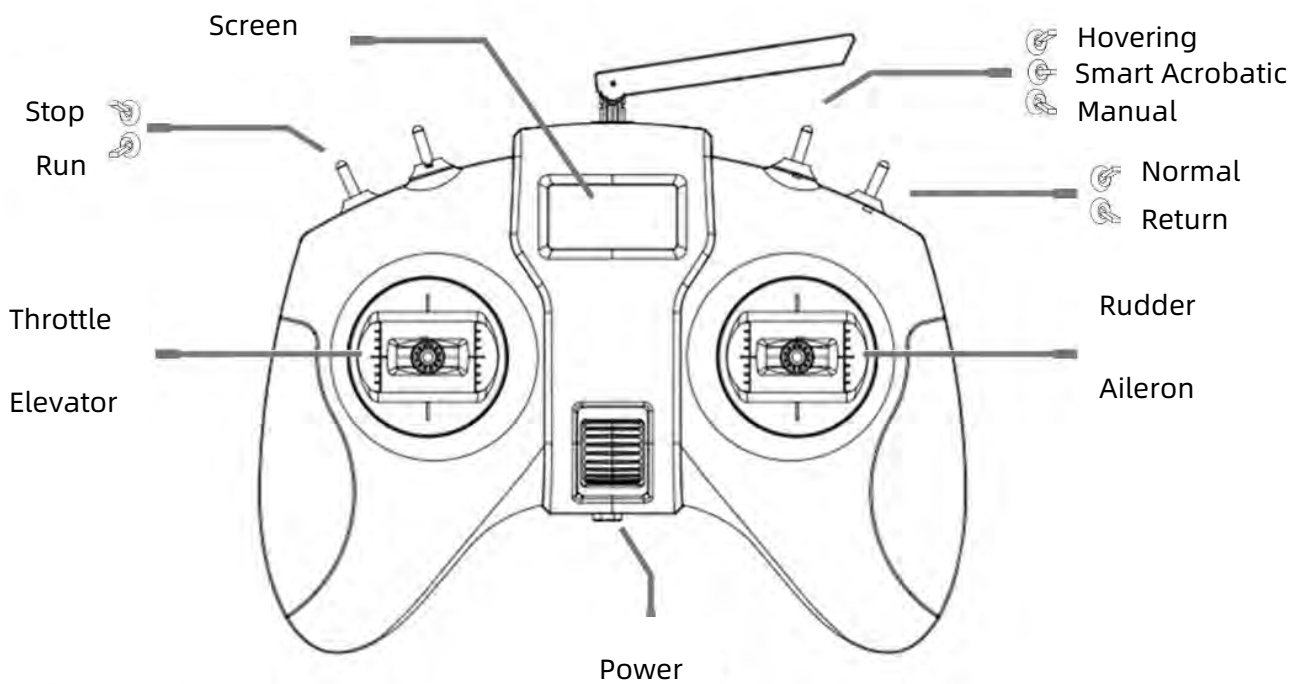

Stick Function

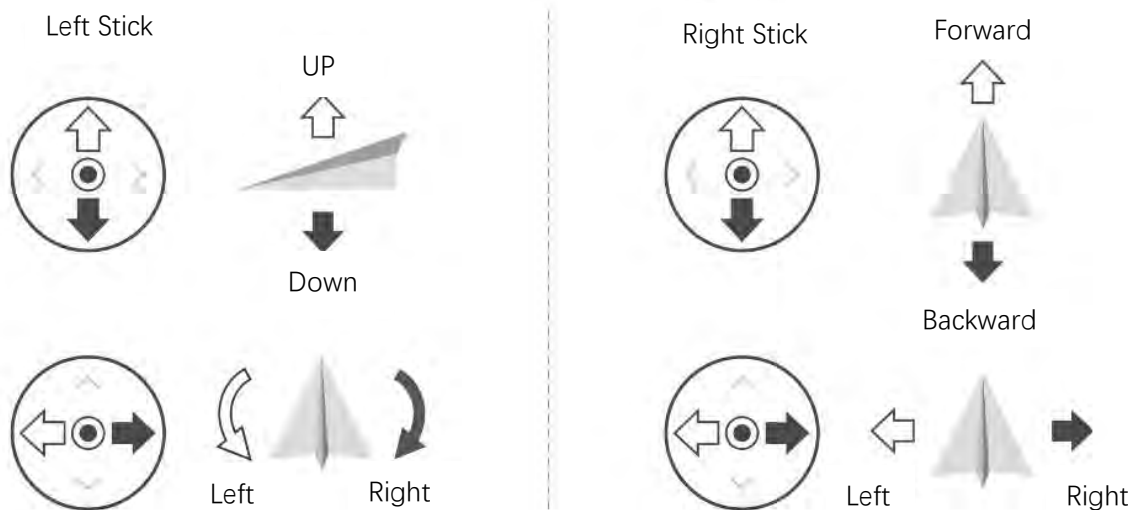

* The maximum communication distance is measured in the experimental environment for reference only.

Operate your FW200 helicopter

1. Star your transmitter

Star the transmitter,dial the switch to Stop-Hovering-Normal

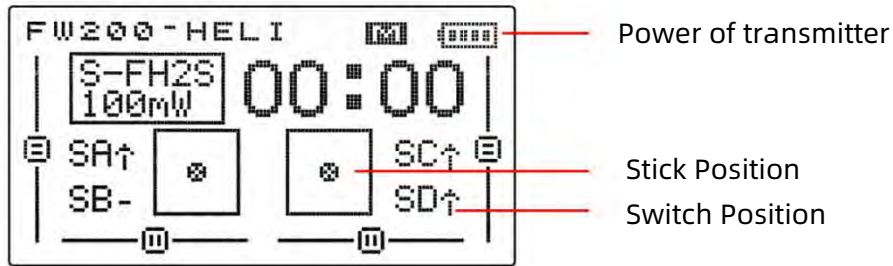

2. Connect the power

Remove the canopy, bind helicopter battery with battery board,insert into the helicopter,supply power, stand the helicopter.

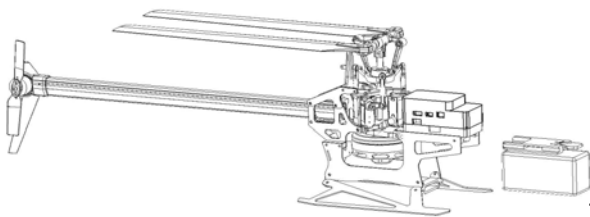

The battery yellow's plug is connected to helicopter plug

3. Charge battery/transmitter

Please take the helicopter battery out.

- Connect the charger with AC Power(100~240 V,50/60 Hz)until POWER light.
- Before charging, make sure the battery temperature is normal and the battery white balance head is connected to the charger (the yellow plug is not plugged).
- After the charger is connected, the red light is on, and the green light is on after the battery is fully.
- Do not plug in 2s-3s at the same time. Only one battery can be charged at a time.
- The transmitter is charged with Type-C, you can use a standard 5V mobile phone charger,when charging,the red light is always on, full charging, the light is off.

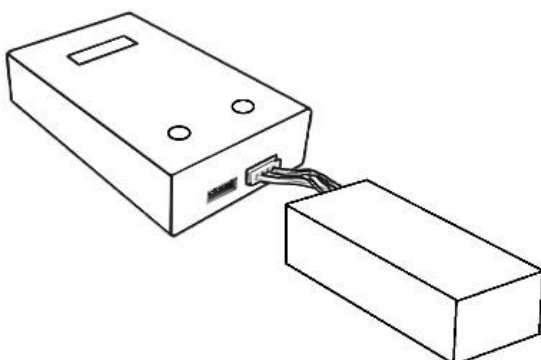

4. Ready to fly

- Please place the helicopter outdoors in a flat and open area, the user facing the tail.
- Hovering mode flight (Sample as mode2)

The hovering mode is the same as simple operation logic as other aerial drone, which is suitable for beginner without drone flight experience.

1. Flip the switch to 'Stop' - 'Hovering' until the light of helicopter is green flash



2. If flying outdoor. You can fly helicopter after the light is green solid, after GPS successful, the RETURN is available, return point is takeoff point.



3. Flip switch to star, main blade will spin, Push the throttle, The blade is slowly accelerated until it takes off (about 10 seconds).



4. Hold pulling the stick, FW200 Landed slowly, After stable landing, flip stop switch, motor stop running.



- Do not stop the motor during flight, otherwise the helicopter will crash. Unless there are special circumstances (e.g. the helicopter may collide with a crowd), it is necessary to stop the motor urgently to minimize the injury.
- The helicopter will not be able to take off in case of serious low power alarm.
- After starting the helicopter motor, the blade will rotate at high speed, which is dangerous. The operator shall keep a certain distance from the helicopter and keep the helicopter away from the crowd, buildings, trees or other obstructions to avoid collision.
- After landing, please turn off the helicopter power first and then the transmitter.

● Full manual mode(Sample as Mode 2)

After the manual mode is turned on, all flight assistance functions will be turned off, and the user is required to master the control of stunt helicopter The non self stable control mode of the helicopter is suitable for 3D professional users. Under this function, when the helicopter is low power, only the red light flashes and gives an alarm, and the helicopter does not return or land.

1. Flip the switch to Stop.Change the mode to Manual
Until the light is blue solid.



2. Flip switch to star , the motor begins to accelerate to set speed.Push throttle to flight.
During takeoff, the helicopter will drift and tilt because there is no self stabilization. At this time, it is necessary to constantly operate and correct the helicopter



3.Pull down the throttle,control the helicopter to land stably on the ground, switch to stop and the motor stops rotating.



About full manual 3D mode:

When the helicopter is flying in the air,flip GPS to 3D,The helicopter will fall quickly,if you are beginner,it is very dangerous and the helicopter will crash. Experience pilots can quickly and manually increase the pitch control after switching to 3D mode

● Indoor visual positioning take-off (Sample as mode2) visual orientation

FW200 equipped with vision system positing and posting system , supply for position sensor function.The positioning function of the vision system is applicable to the environment without GPS (GNSS) signal or poor GPS (GNSS) signal , working height 0.5m-2m.Under positing mode and GPS (GNSS) cannot downward vision system will auto star.

1. Flip switch to Stop and Hovering, wait until the servo self-test complete.



2. Wait for the green light of the helicopter to flash in the environment with sufficient light and clear ground texture



4. Flip switch to 3D, motor starts to rotate, push throttle. The blades will rotate until takeoff (about 10s)



4. Hold pulling the stick, FW200 Landed slowly, After stable landing, flip stop switch, motor stop running.



Please pay attention to the flight environment. The vision system and laser altitude system only play a safety auxiliary role under limited conditions. The user maintains control of the helicopter and is responsible for the operation behavior throughout the process.

In the absence of GPS (GNSS), when using the vision system in an open and flat suitable site, the working range of the helicopter is 0.5m-2m, and the maximum flight altitude of the helicopter is limited to 2m, so it cannot continue to rise. Please fly with caution.

- The vision system cannot work properly over water surfaces.
- The vision system cannot work properly over surfaces
- that don't have clear pattern variations. The vision system cannot work properly in any situation
 1. Monochrome surface (e.g., pure black, pure white, pure green)
 2. Highly reflective surfaces (e.g., ice, ceramic tile)
 3. Water or transparent surfaces
 4. Moving object surface
 5. Area where the lighting changes frequently or drastically.
 6. Extremely dark or bright surfaces





7. Surfaces that reflect or absorb infrared waves (e.g., mirrors)
8. Surfaces with particularly sparse texture.
9. Surfaces with repeating identical patterns or textures (e.g., tiles with the same design)

4. Return mode

If you use return mode (one key return, low power return), please ensure the GPS signal is good. There are no buildings or trees near the takeoff point that hinder the return. Takeoff after green light solid.

● Smart Return

- The helicopter will auto return when flipping the switch to Return. Flip switch to Normal to stop return.
- Low power return: when the power system judges that the current power is low. It will auto return and land. Please ensure that current distance of the helicopter meets the range of remaining power. When the low power return, within 6 meters from the take-off point, the helicopter will land in original place. Beyond 6 meters, the helicopter will climb to 6 meters and above, when flying back, it is not controlled by the pilot. If there are obstacles such as trees and buildings on the way back, it is necessary to manually terminate the auto flight.
- Low power alarm (GPS mode) :
 - Level 1 alarm: The red light flashes and accompanied by a drip slow alarm.
 - Level 2 alarm: helicopter fast drip alarm and return.
 - Level 3 alarm: Helicopter will force land.
- Low power alarm (vision system mode) :
 - Level 1 alarm: The red light flashes and accompanied by a drip slow alarm.
 - Level 2 alarm: helicopter fast drip alarm.
 - Level 3 alarm: Helicopter will force land.





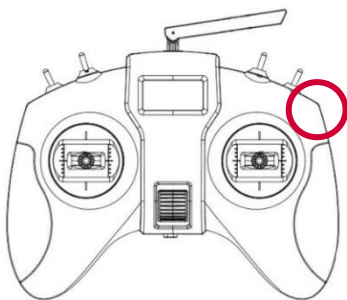

● Method of stopping low power return

- If you need to stop the low power return, flip the switch to Return, then flip the switch to Normal. You can manually control the helicopter landing, close motor manually after landing. During this period, the helicopter will no longer return at low power until the helicopter lands forcibly.



5. Appendix

Flight status indicator

	Green flash	Vision positing,no return function
	————	Green solid	GPS position is OK, Return function star, record home point
	Yellow flash	Visual positioning failure, helicopter unable to take off
	————	Blue solid	Full manual mode
	Red flash and drip slow alarm	Low power, level 1 alarm
	Red flash and drip quick alarm	Low power,level 2 alarm
	————	Red solid	Lower power, level 3 alarm

6. Smart acrobatic mode

- It is suitable for users with certain flight experience and pursuing more acrobatic flight experience.
- After the helicopter inverted,you can control it action and height.If you want helicopter normal to fly,please climb it 3m over ground,and flip the stick from right to middle quickly ,it will be normal flight.
- The home function will fail in the inverted mode. Please pay attention to the flight power.
- This function can only be used when it is more than 3m above the ground.
- This function depends on GPS signal. Please use this function in an environment with sufficient GPS satellite signal in open land.
- Due to the intense rolling, please ensure that the helicopter has sufficient power.
- Inverted flight mode: easy inverted flight mode,experts inverted flight mode.
- Easy inverted flight mode:
This mode is for beginner who can experience the fun of an inverted flight..The factory default is easy mode.Quickly push stick then to middle,the helicopter will invert and hovering.This moment,the operation is same as normal(push throttle,the helicopter inverted climb, push forward stick,the helicopter towards to the nose).
- Experts inverted flight mode:
This mode is applicable to 3D training operation , You can practice 3D basic hovering operation with the help of GPS.Turn on the function on software,Quickly push stick then to middle,the helicopter will invert and hovering.This moment,the operation is same as 3D(Push throttle,the helicopter inverted descent,push forward stick,the helicopter towards to the tail).

1. On smart acrobatic mode,quickly flip the stick from middle to right



2. Flip the stick to right,and then quickly return to the middle,the helicopter began to roll auto





This is test function, because each helicopter's power and performance are different, the inverted effect will be different. By default, this function cannot be used within 3M height. Don't use this function near residential areas and buildings.

When the user opens this function, it is known by default that this function is a test function. The user shall bear the adverse effects and consequences such as helicopter failure caused by using this function.

7. Calibrate compass

Compass is easy to be disturbed by strong electric field, strong magnetic field and strong electromagnetic field, which will lead to abnormal and even cause flight accident. Regular calibration can make the compass work at its best.

● Precautions

1. Don't calibrate in the field of strong magnetic and electric or near large metal, such as magnetic ore, parking
2. When calibrating, don't carry ferromagnetic materials, such as keys, watches, speakers, etc.
3. If calibration indoors, remember to re-calibrate when changing to outdoor flight to prevent compass abnormality during flight.
4. Please move the helicopter to another field when there may be steel materials affecting the compass.

● Step

On an open field, calibrate the compass according to the steps below. For more information, please visit <https://www.flywingrc.com/en/> watch relevant teaching video.

Method: calibration by adjustment software:

1. Visit <https://www.flywingrc.com/software/> to download software.
2. Using Bluetooth connect the helicopter and APP
3. Select compass calibration on software, select star calibrating
5. Rotate the helicopter rotor to the upper surface of 360°; the head is vertically rotated 360°; and the left upward level is rotated 360°.
6. If the progress bar doesn't end, repeat the above operation until the end of the calibration progress bar indicates that the calibration is successful.



Need to re-calibrate

1. APP displays compass abnormality.
2. The flight site is far from the last compass calibration site.
3. The structure of the helicopter has changed.
4. The flight drift is serious, or it cannot fly in a straight line

10. Change the mode of transmitter

1. Scroll the transparent scroll wheel, select the M icon, and press the scroll wheel

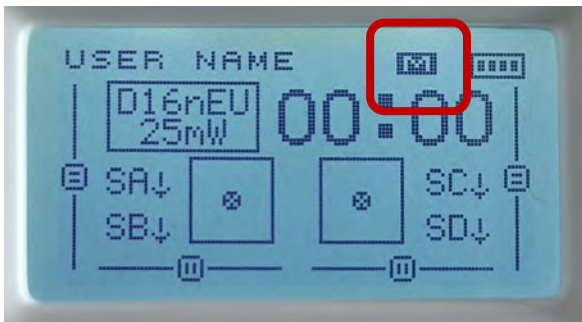

2. Scroll the transparent scroll wheel, select the pattern, press the scroll wheel

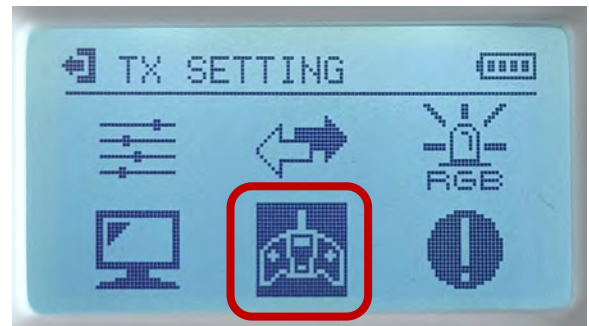

3. Scroll the transparent scroll wheel, select STICK select the mode you want.

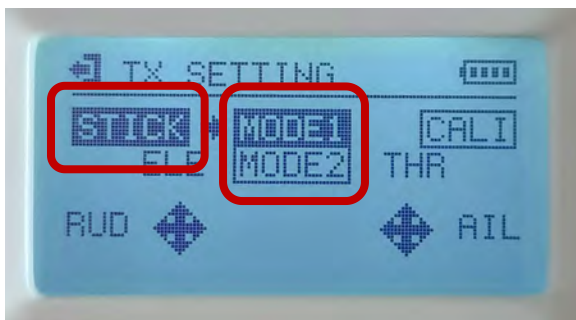

4. Scroll the transparent scroll wheel, select the pattern, press scroll wheel, back to main menu

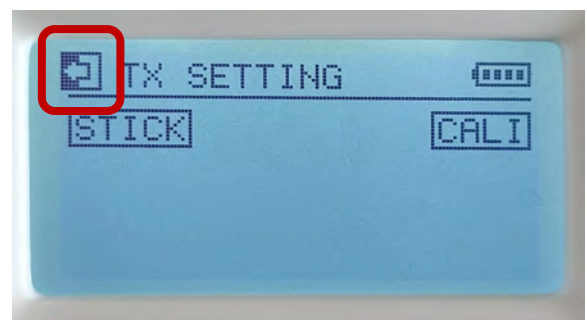

Contents:

FW200*1

Transmitter (RTF version)

Battery*1 (RTF version)

Charger*1 (RTF version)



Flywing ACRO Technology Co.,Ltd

www.flywingrc.com

